

Article number: 01010931  
 Description: Retaining ring A 90 DIN 471  
 Stainless 411  
 Note: Fitted with ZGA pilers

## Measures

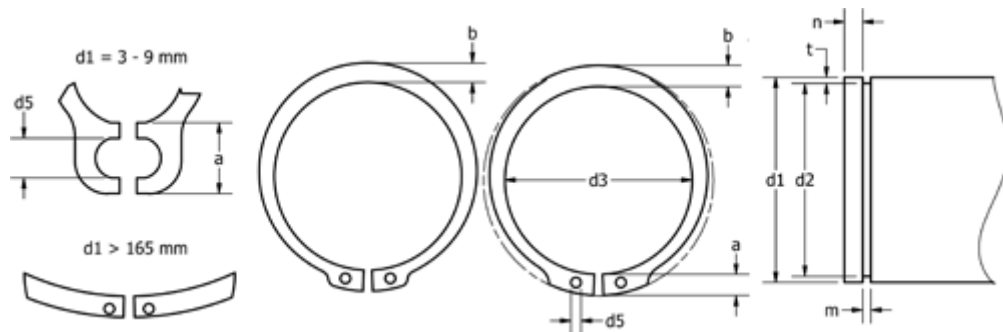

a max	= 8.8	FN kN	= 80.0	s	= 3.00
AN mm <sup>2</sup>	= 485.0	FRg kN	= 34.40	t	= 1.75
b	= 82.0	FR kN	= 217.00	tol	= -0.35
d1	= 90	g	= 3.0	tol	= -0.08
d2	= 86.5	K kN-mm	= 401.00	tol	= +0,54-1,30
d3	= 84.5	m min	= 3.15	Tong	= ZGA-4
d5 min	= 3.5	n abl x 1000	= 5.0	Weight kg/1000	= 44.500
Description	= A90	Nominal drive	= 5.3		